

LPC-E2468 development board

Users Manual

Rev.B, February 2008

Copyright(c) 2008, OLIMEX Ltd, All rights reserved

INTRODUCTION:

LPC-E2468 uC Linux development prototype board with LPC2468 USB, Ethernet, SD/MMC in credit card format.

BOARD FEATURES:

- MCU: **LPC2468**;
- 16MB SDRAM;
- 128 MB NAN Flash;
- standard JTAG connector with ARM 2x10 pin layout for programming/debugging with ARM-JTAG;
- Ethernet 100MBit;
- 2x USB hosts;
- USB-to-RS232 converter device connected to LPC2468 UART;
- SD/MMC card connector;
- UEXT connector with I2C, SPI, RS232 and power supply for connecting add-on modules like RF link, MP3, etc available from Olimex;
- trimpot connected to ADC;
- RESET circuit with external control of Philips ISP utility via RS232 port;
- two USER button;
- RESET Button;
- two on board voltage regulators 3V and 5V with up to 800mA current;
- Extension port connector for many of microcontrollers pins;
- single power supply: External power supply, USB or JTAG connector;
- Battery holder and connector for the RTC;
- power supply led;
- FR-4, 1.5 mm, red soldermask, component print;
- Dimensions: 90x60mm (3.54 x 2.36").

ELECTROSTATIC WARNING:

The LPC-E2468 development board is shipped in protective anti-static packaging. The board must not be subject to high electrostatic potentials. General practice for working with static sensitive devices should be applied when working with this board.

BOARD USE REQUIREMENTS:

- Cables:** USB A-B cable to connect to virtual serial port on the board. You will need LPT cable if you want to program the MCU with AVR-JTAG. You might need other cables in case of other programmers/debuggers.
- Hardware:** Programmer/debugger AVR-JTAG or any compatible tool.
- Software:** The board is delivered with uC Linux pre-loaded. You could develop projects for the board with Eclipse, IAR, etc. Please, refer to the **LPC-E2468 Quickstart Guide** which is on the CD for more details on the software requirements.

PROCESSOR FEATURES:

The **LPC2468** processor has the following features:

- ARM7TDMI-S processor, running at up to 72 MHz.
- 512 kB on-chip flash program memory with In-System Programming (ISP) and In-Application Programming (IAP) capabilities. Flash program memory is on the ARM local bus for high performance CPU access.
- 98 kB on-chip SRAM includes:
 - 64 kB of SRAM on the ARM local bus for high performance CPU access.
 - 16 kB SRAM for Ethernet interface. Can also be used as general purpose SRAM.
 - 16 kB SRAM for general purpose DMA use also accessible by the USB.
 - 2 kB SRAM data storage powered from the Real-Time Clock (RTC) power domain.
- Dual Advanced High-performance Bus (AHB) system allows simultaneous Ethernet DMA, USB DMA, and program execution from on-chip flash with no contention.
- EMC provides support for asynchronous static memory devices such as RAM, ROM and flash, as well as dynamic memories such as Single Data Rate SDRAM.
- Advanced Vectored Interrupt Controller (VIC), supporting up to 32 vectored interrupts.
- General Purpose AHB DMA controller (GPDMA) that can be used with the SSP,
- I²S-bus, and SD/MMC interface as well as for memory-to-memory transfers.
- Serial Interfaces:
 - Ethernet MAC with MII/RMII interface and associated DMA controller. These functions reside on an independent AHB bus.
 - USB 2.0 full-speed dual port Device/Host/OTG Controller with on-chip PHY and associated DMA controller.

- Four UARTs with fractional baud rate generation, one with modem control I/O, one with IrDA support, all with FIFO.
- CAN controller with two channels.
- SPI controller.
- Two SSP controllers, with FIFO and multi-protocol capabilities. One is an alternate for the SPI port, sharing its interrupt. SSPs can be used with the GPDMA controller.
- Three I²C-bus interfaces (one with open-drain and two with standard port pins).
- I²S (Inter-IC Sound) interface for digital audio input or output. It can be used with the GPDMA.
- Other peripherals:
 - SD/MMC memory card interface.
 - 160 General purpose I/O pins with configurable pull-up/down resistors.
 - 10-bit ADC with input multiplexing among 8 pins.
 - 10-bit DAC.
 - Four general purpose timers/counters with 8 capture inputs and 10 compare outputs. Each timer block has an external count input.
 - Two PWM/timer blocks with support for three-phase motor control. Each PWM has an external count inputs.
 - RTC with separate power domain, clock source can be the RTC oscillator or the APB clock.
 - 2 kB SRAM powered from the RTC power pin, allowing data to be stored when the rest of the chip is powered off.
 - WatchDog Timer (WDT). The WDT can be clocked from the internal RC oscillator, the RTC oscillator, or the APB clock.
- Standard ARM test/debug interface for compatibility with existing tools.
- Emulation trace module supports real-time trace.
- Single 3.3 V power supply (3.0 V to 3.6 V).
- Three reduced power modes: idle, sleep, and power-down.
- Four external interrupt inputs configurable as edge/level sensitive. All pins on PORT0 and PORT2 can be used as edge sensitive interrupt sources.
- Processor wake-up from Power-down mode via any interrupt able to operate during Power-down mode (includes external interrupts, RTC interrupt, USB activity, Ethernet wake-up interrupt, CAN bus activity, PORT0/2 pin interrupt).
- Two independent power domains allow fine tuning of power consumption based on needed features.
- Each peripheral has its own clock divider for further power saving. These dividers help reducing active power by 20 - 30 %.
- Brownout detect with separate thresholds for interrupt and forced reset.

- On-chip power-on reset.

On-chip crystal oscillator with an operating range of 1 MHz to 24 MHz.

- 4 MHz internal RC oscillator trimmed to 1 % accuracy that can optionally be used as the system clock. When used as the CPU clock, does not allow CAN and USB to run.
- On-chip PLL allows CPU operation up to the maximum CPU rate without the need for a high frequency crystal. May be run from the main oscillator, the internal RC oscillator, or the RTC oscillator.
- Boundary scan for simplified board testing.
- Versatile pin function selections allow more possibilities for using on-chip peripheral functions.

BLOCK DIAGRAM:

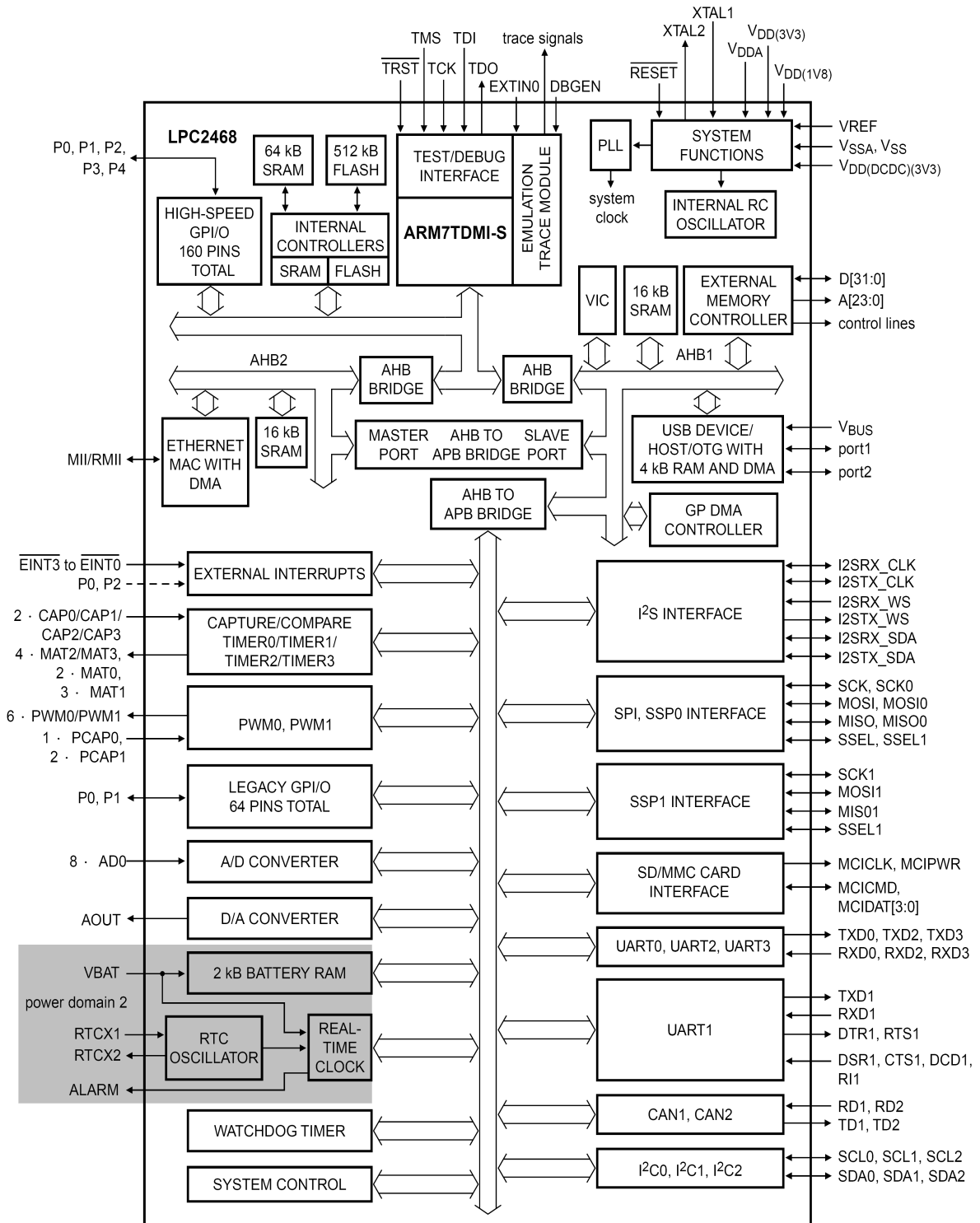

MEMORY MAP:

LPC2468 memory map

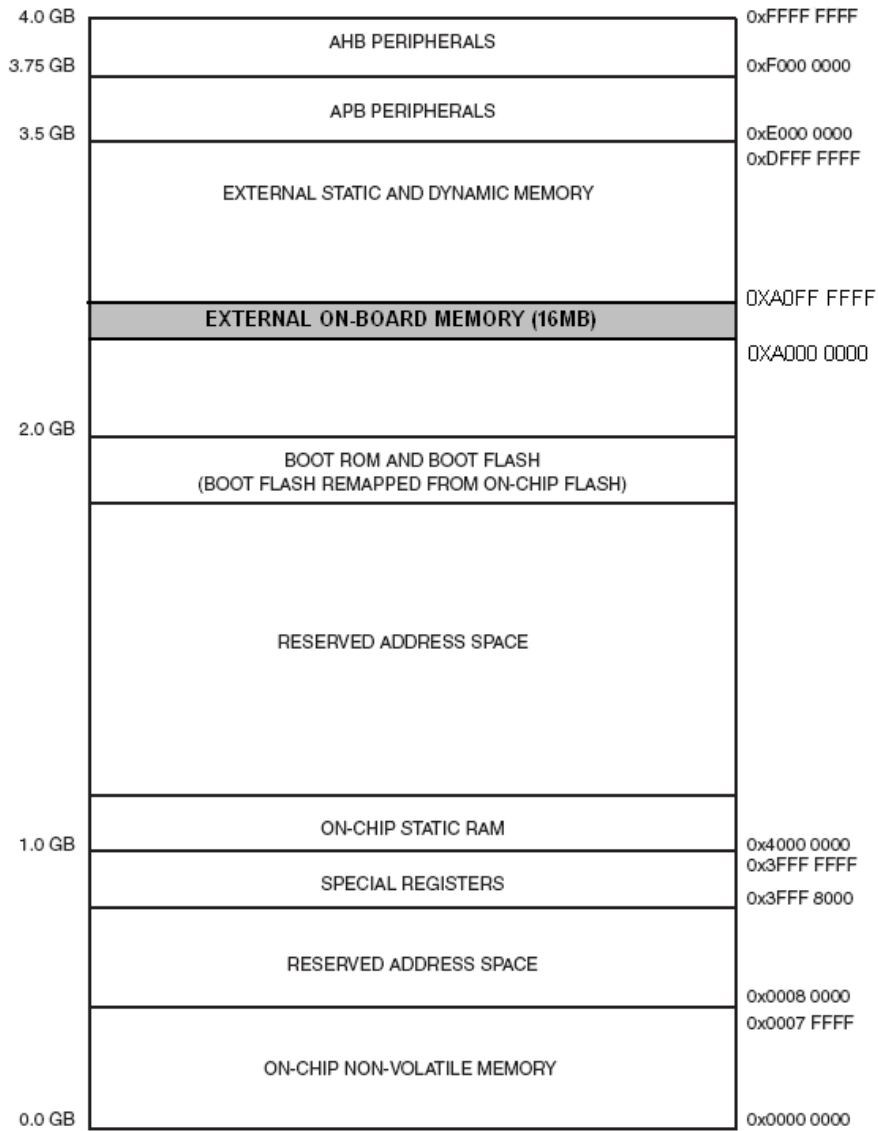

SCHEMATIC:

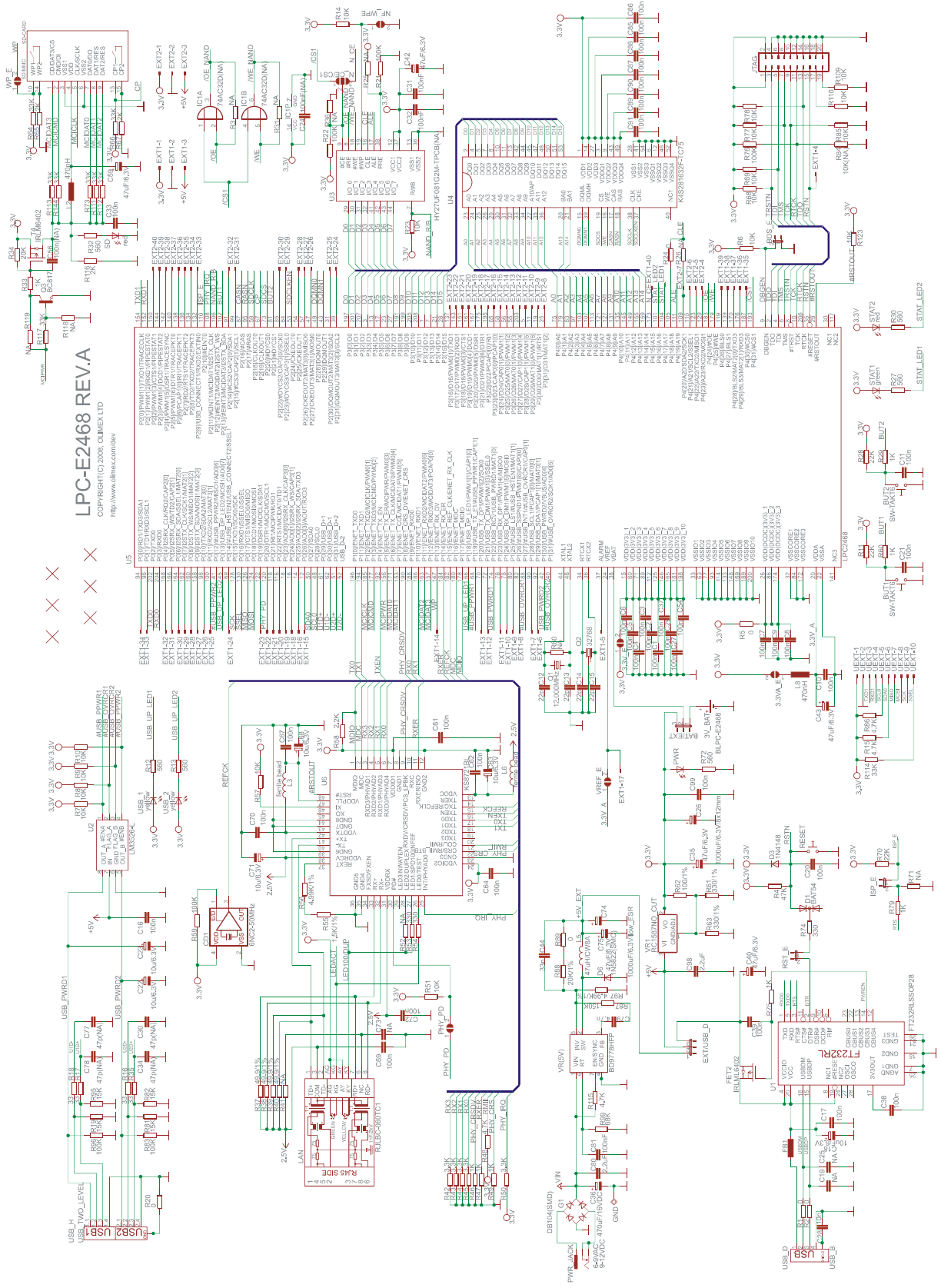

BOARD LAYOUT:

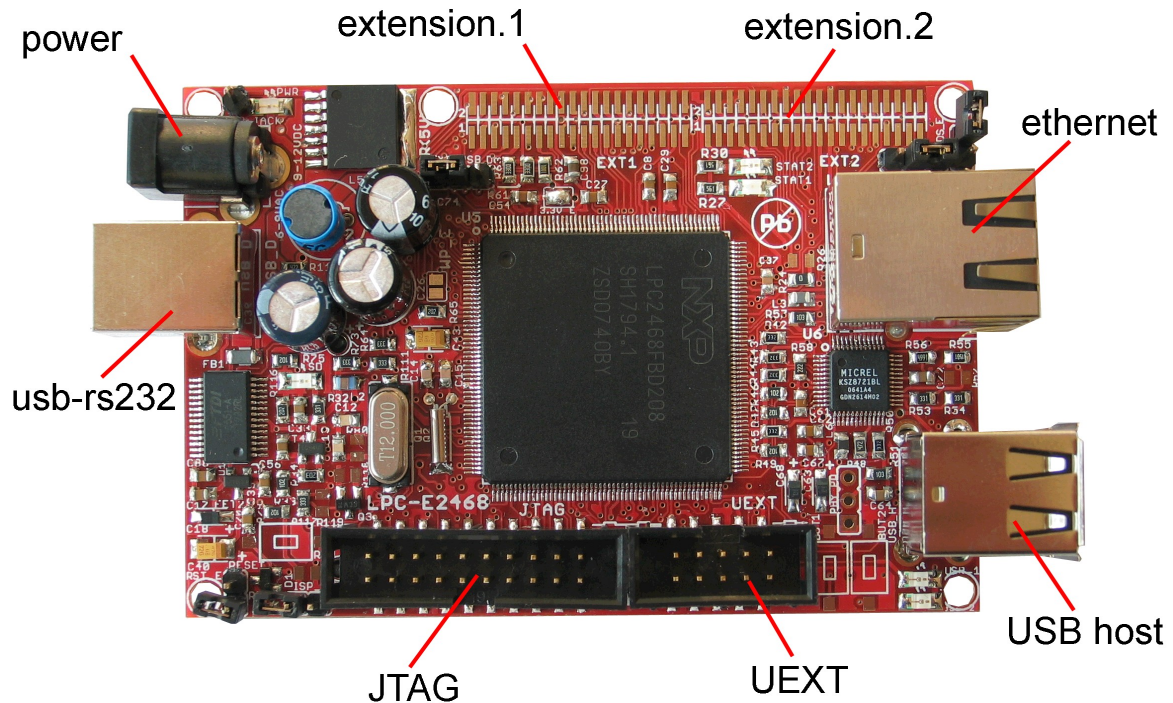

POWER SUPPLY CIRCUIT:

LPC-E2468 can take power from power connector PWR, where +(9-12) VDC or (6-9) VAC external voltage source has to be applied. The board could also take power from USB_D or from battery. Note: the battery only supplies the internal 2MB SRAM and the RTC.

The board power consumption is: about 150 mA at 9VDC.

RESET CIRCUIT:

LPC-E2468 reset circuit is made with RC group R4 – 47K, C20 – 100nF and RESET button.

CLOCK CIRCUIT:

Quartz crystal 12MHz is connected to **LPC2468** pin 44 (XTAL1) and pin 46 (XTAL2).

32.768 KHz quartz crystal is connected to **LPC2468** pin 34 (RTCX1) and pin 36 (RTCX2) for its internal Real Time Clock.

JUMPER DESCRIPTION:

3.3V_E
VDD1-10 pins  of the MCU. This jumper, when closed, supplies 3.3 V voltage to the of the MCU.
Default state is closed.

3.3VA_E
pin of the  This jumper, when closed, supplies 3.3 V voltage to the VDDA MCU.
Default state is closed.

VREF_E
the VREF pin  This jumper, when closed, supplies 3.3 V reference voltage to of the MCU.
Default state is closed.

PHY_PD
If the jumper  controls the PHY. This jumper controls the PHY signal of the Ethernet controller. is pen the PHY is always enabled, if the pin is closed the MCU
Default state is open.

WP_E
the SD/MMC  This jumper, when closed, inputs the Write protect signal from card to the MCU.
Default state is closed.

NF_WPE
open, disables  This jumper, when closed, write-protects the flash and when the write protection.
Default state is open.

N_CE/CS1
work through  the pin of the NAND flash MCU. When 1-2 is shorted, you could select the flash memory for the Chip Select 1 signal. If 2-3 is shorted, the #CE memory is connected to the N_CE pin of the MCU.
Default position is 1-2 shorted.

ISP_E
Programming).  This is used when you want external software to program the **LCP2478**. This jumper is used in combination with the RST_E jumper.
Default state is open.

RST_E
the Reset  software to program the **LCP2478**. This jumper is used in combination with the ISP_E jumper.
Default state is open.

BDS_E

Boundary scan enable.
Default state is open.

BAT/EXT

This jumper controls the input power supply for the VBAT pin.

If 1-2 are shorted, the external battery is connected to the VBAT pin.



1 2 3

If 2-3 are shorted, the VBAT pin is supplied by the on-board +3.3V supply.



1 2 3

Default state is 2-3 shorted.

EXT/USB_D

This jumper controls 3.3V power supply for the board.

If 1-2 are shorted, the external power (from the PWR jack and after the +5V voltage regulator) is input to the +3.3V voltage regulator and supplies the board.



1 2 3

If 2-3 are shorted, the USB device provides +5V to the voltage regulator and supplies the board.



1 2 3

Default state is 1-2 shorted.

INPUT/OUTPUT:

One **reset button** with name **RESET** – connected to LPC2468 pin 35 (#RESET).

Two **user buttons** with names **BUT1** – connected to LPC2468 pin 102 (P2[13]/#EINT3/MCIDAT3/I2STX_SDA) and **BUT2** – connected to LPC2468 pin 81 (P2[21]/#DYCS1);

Two **LEDs** named **STAT1**(green) and **STAT2**(red) – connected to LPC2468 pin 104 (P4[17]/A17) and LPC2468 pin101 (P4[16]/A16);

Two yellow **LEDs** named **USB_1** and **USB_2** – connected to LPC2468 pin 66 (P1[18]/USB_UP_LED1/PWM1[1]/CAP1[0]) and LPC2468 pin 45 (P0[13]/USB_UP_LED2/MOSI1/AD0[7]);

One red **LED** named **SD** indicating that SD/MMC card is powered up;

Power supply red LED with name **PWR** – indicates that 3.3V is present.

EXTERNAL CONNECTOR DESCRIPTION:

PWR:

| Pin # | Signal Name |
|-------|-------------|
| 1 | PWR |
| 2 | GND |

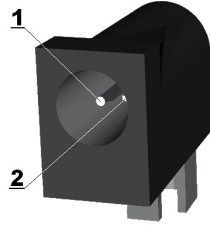

You should apply voltage +(9-12)VDC or (6-9) VAC at the PWR pin.

USB_D:

| Pin # | Signal Name |
|-------|-------------|
| 1 | VCC |
| 2 | USBDM |
| 3 | USBDP |
| 4 | GND |

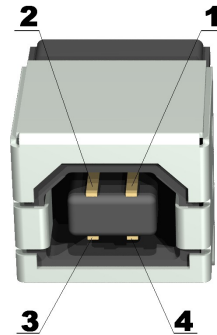

USBDM, USBDP These signals form the differential input/output for the USB device depending on the direction of the data flow.

USB H:

| Pin # | Signal Name | Pin # | Signal Name |
|-------|-------------|-------|-------------|
| 1 | USB_PWRD1 | 5 | USB_PWRD2 |
| 2 | U1D- | 6 | U2D- |
| 3 | U1D+ | 7 | U2D+ |
| 4 | GND | 8 | GND |

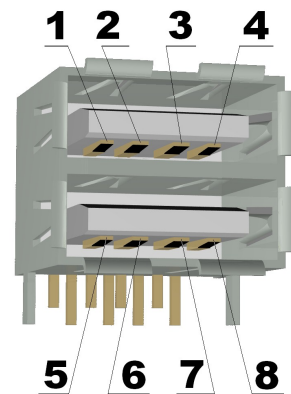

USB_PWRD1 Output USB Power 1. This signal is output from the processor and input for the USB host 1.

U1D-, U1D+ I/O This signals form the differential input/output for USB host 1 depending on the direction of the data transfer.

USB_PWRD2 Output USB Power 2. This signal is output from the processor and input for the USB host 2.

U2D-, U2D+ I/O This signals form the differential input/output for USB host 2 depending on the direction of the data transfer.

JTAG:

| Pin # | Signal Name | Pin # | Signal Name |
|-------|-------------|-------|-------------|
| 1 | 3.3V | 2 | 3.3V |
| 3 | TRSTN | 4 | GND |
| 5 | TDI | 6 | GND |
| 7 | TMS | 8 | GND |
| 9 | TCK | 10 | GND |
| 11 | RTCK | 12 | GND |
| 13 | TDO | 14 | GND |
| 15 | RSTN | 16 | GND |
| 17 | 10K to GND | 18 | GND |
| 19 | 10K to GND | 20 | GND |

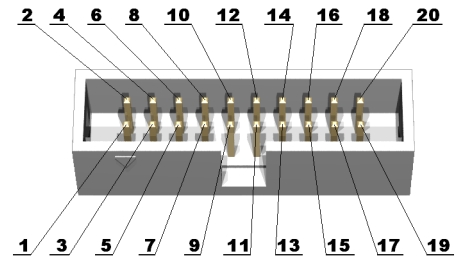

TDI Input **Test Data In**. This is the serial data input for the shift register.

TDO Output **Test Data Out**. This is the serial data output for the shift register. Data is shifted out of the device on the negative edge of the TCK signal.

TMS Input **Test Mode Select**. The TMS pin selects the next state in the TAP state machine.

TCK Input **Test Clock**. This allows shifting of the data in, on the TMS and TDI pins. It is a positive edge triggered clock with the TMS and TCK signals that define the internal state of the device.

TRSTN Input **Test Reset N**. This signal resets the JTAG controller.

RTCK Output **Return Clock**. This is a synchronization signal which the JTAG connector uses to acknowledge it is ready to receive/transmit.

RSTN Input **Reset**. This signal resets the MSU.

JTAG is used to to program and debug the MCU.

UEXT:

| Pin # | Signal Name | Pin # | Signal Name |
|-------|-------------|-------|-------------|
| 1 | 3.3V | 2 | GND |
| 3 | TXD1 | 4 | RXD1 |
| 5 | SCL0 | 6 | SDA0 |
| 7 | MISO | 8 | MOSI |
| 9 | SCK | 10 | SSEL |

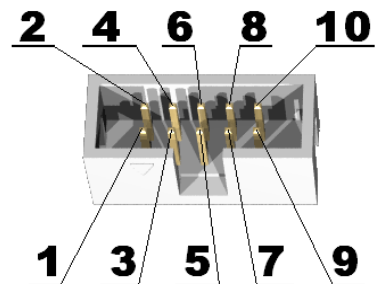

TXD1 Output **Transmit Data**. This is the asynchronous serial data output (RS232) for the RS232 interface.

RXD1 Input **Receive Data**. This is the asynchronous serial data input (RS232) for the RS232 interface.

SCLO I/O **Serial (Synchronization) Clock**. This is the synchronization clock for the data transfer through I2C interface. This could be either input or output depending on whether the MCU is master or slave.

SDAO I/O **Serial Data**. This pin is data input or output (depending on the data flow direction) for the I2C interface.

MISO I/O **Master In Slave Out**. This pin could be either data input (MCU is master) or data output (MCU is slave). The signal is part of the SPI interface.

MOSI I/O **Master Out Slave In**. This pin is used for communication through SPI interface and it is either data output from the MCU (when it is master) or data input for the MCU (when it is slave).

SCK I/O **Serial (Synchronization) Clock**. This is the synchronization clock for the data transfer through the SPI interface. It could be either input or output depending on whether the MCU is master or slave.

SSEL I/O **Slave Select**. This is the slave select signal for the SPI interface. If the MCU is master, this is output. If the MCU is slave, this signal is input.

LAN:

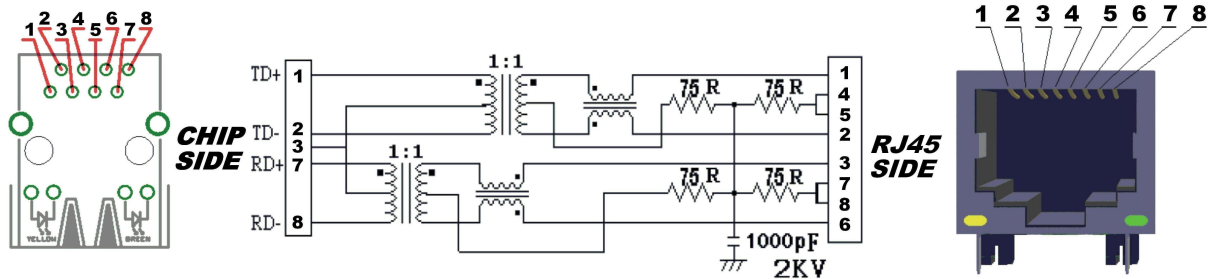

| Pin # | Signal Name Chip Side | Pin # | Signal Name Chip Side |
|-------|-----------------------|-------|-----------------------|
| 1 | TD+ | 5 | Not Connected (NC) |
| 2 | TD- | 6 | Not Connected (NC) |
| 3 | 3.3V | 7 | RD+ |
| 4 | Not Connected (NC) | 8 | RD- |

| LED | Color | Usage |
|-------|--------|-------------------------------|
| Right | Yellow | Activity |
| Left | Green | 100Mbits/s (Half/Full duplex) |

TD- Output Differential signal output. This signal is output from the MCU.

TD+ Output Differential signal output. This signal is output from the MCU.

RD- Input Differential signal input. This signal is input for the MCU.

RD+ Input Differential signal input. This signal is input for the MCU.

SD/MMC card slot:

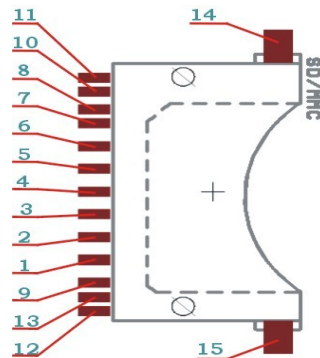

| Pin # | Signal Name | Pin # | Signal Name |
|-------|-------------|-------|-------------|
| 1 | MCIDAT3 | 2 | MCICMD |
| 3 | GND (VSS1) | 4 | VDD |
| 5 | MCICLK | 6 | GND (VSS2) |
| 7 | MCIDAT0 | 8 | MCIDAT1 |
| 9 | MCIDAT2 | 10 | WP |
| 11 | - | 12 | - |
| 13 | CP | 14 | GND |
| 15 | GND | | |

MCIDAT0-3 I/O **Memory Card Interface Data 0-4.** These are the data lines for the SD/MMC connector. They could be both input and output for the MCU depending on the data flow direction.

MCICMD Output **Memory Card Interface Command.** This is a command sent from the processor to the memory card and as such it is output from the processor.

MCICLK Output **Memory Card Interface Clock.** This signal is output from the MCU and synchronizes the data transfer between the memory card and the MCU.

WP Input **Write Protect.** This signal is input for the MCU.

CP Input **Card Present.** This signal is input for the MCU.

EXT1&EXT2:

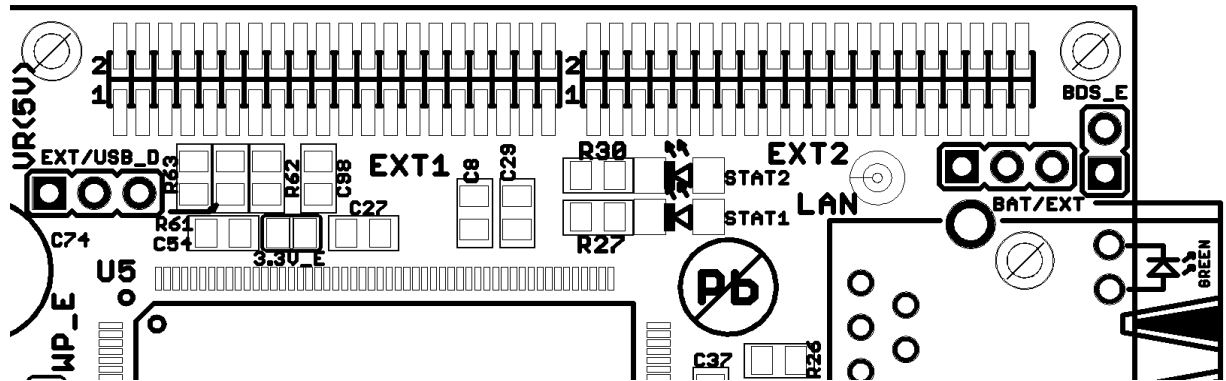

| Pin # | Signal Name | Pin # | Signal Name | Pin # | Signal Name | Pin # | Signal Name |
|---------|-------------|---------|-------------|---------|-------------|---------|-------------|
| EXT1-1 | 3.3V | EXT1-2 | GND | EXT2-1 | 3.3V | EXT2-2 | GND |
| EXT1-3 | +5V | EXT1-4 | RSTN | EXT2-3 | +5V | EXT2-4 | P4[23] |
| EXT1-5 | ALARM | EXT1-6 | P1[29] | EXT2-5 | P4[22] | EXT2-6 | P4[21] |
| EXT1-7 | P1[28] | EXT1-8 | P1[26] | EXT2-7 | P4[20] | EXT2-8 | P3[31] |
| EXT1-9 | P1[25] | EXT1-10 | P1[24] | EXT2-9 | P3[30] | EXT2-10 | P3[29] |
| EXT1-11 | P1[23] | EXT1-12 | P1[21] | EXT2-11 | P3[28] | EXT2-12 | P3[27] |
| EXT1-13 | P1[20] | EXT1-14 | WP | EXT2-13 | P3[26] | EXT2-14 | P3[25] |
| EXT1-15 | P0[26] | EXT1-16 | P0[25] | EXT2-15 | P3[24] | EXT2-16 | P3[23] |
| EXT1-17 | VREF | EXT1-18 | P0[24] | EXT2-17 | P3[22] | EXT2-18 | P3[21] |
| EXT1-19 | P0[23] | EXT1-20 | P0[22] | EXT2-19 | P3[20] | EXT2-20 | P3[19] |
| EXT1-21 | P0[21] | EXT1-22 | PHY_PD | EXT2-21 | P3[18] | EXT2-22 | P3[17] |
| EXT1-23 | P0[19] | EXT1-24 | P0[14] | EXT2-23 | P3[16] | EXT2-24 | P2[31] |
| EXT1-25 | P0[11] | EXT1-26 | P0[10] | EXT2-25 | P2[30] | EXT2-26 | P2[27] |
| EXT1-27 | P0[9] | EXT1-28 | P0[8] | EXT2-27 | P2[26] | EXT2-28 | P2[25] |
| EXT1-29 | P0[7] | EXT1-30 | P0[6] | EXT2-29 | P2[23] | EXT2-30 | P2[22] |
| EXT1-31 | P0[5] | EXT1-32 | P0[4] | EXT2-31 | P2[15] | EXT2-32 | P2[14] |
| EXT1-33 | P0[1] | EXT1-34 | P0[0] | EXT2-33 | P2[9] | EXT2-34 | P2[8] |
| EXT1-35 | P4[30] | EXT1-36 | P4[29] | EXT2-35 | P2[7] | EXT2-36 | P2[6] |
| EXT1-37 | P4[28] | EXT1-38 | P4[27] | EXT2-37 | P2[5] | EXT2-38 | P2[4] |
| EXT1-39 | P3[26] | EXT1-40 | P4[15] | EXT2-39 | P2[3] | EXT2-40 | P2[2] |

MECHANICAL DIMENSIONS:

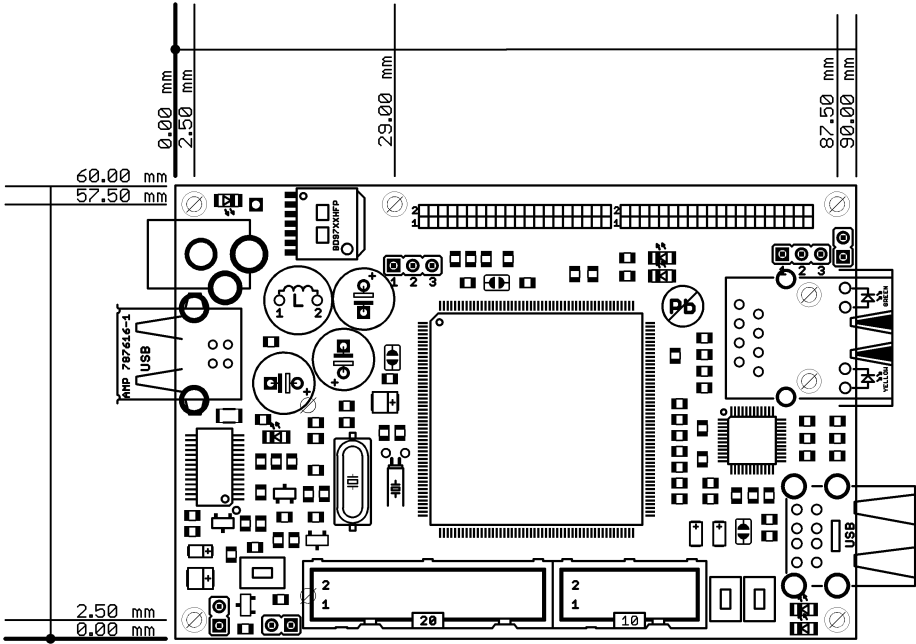

All measures are in mm.

AVAILABLE DEMO SOFTWARE:

LPC-E2468 is delivered pre-loaded with C Linux and the sources and binaries are on the accompanying CD.

ORDER CODE:

LPC-E2468 - assembled and tested (no kit, no soldering required)

How to order?

You can order to us directly or by any of our distributors.

Check our web www.olimex.com/dev for more info.



All boards produced by Olimex are RoHS compliant

Revision history:

REV.A - created February 2008

Disclaimer:

© 2008 Olimex Ltd. All rights reserved. Olimex®, logo and combinations thereof, are registered trademarks of Olimex Ltd. Other terms and product names may be trademarks of others.

The information in this document is provided in connection with Olimex products. No license, express or implied or otherwise, to any intellectual property right is granted by this document or in connection with the sale of Olimex products.

Neither the whole nor any part of the information contained in or the product described in this document may be adapted or reproduced in any material from except with the prior written permission of the copyright holder.

The product described in this document is subject to continuous development and improvements. All particulars of the product and its use contained in this document are given by OLIMEX in good faith. However all warranties implied or expressed including but not limited to implied warranties of merchantability or fitness for purpose are excluded.

This document is intended only to assist the reader in the use of the product. OLIMEX Ltd. shall not be liable for any loss or damage arising from the use of any information in this document or any error or omission in such information or any incorrect use of the product.