

PIC32-WEB development board

Users Manual



All boards produced by Olimex are ROHS compliant

Rev. A, November 2009

Copyright(c) 2009, OLIMEX Ltd, All rights reserved

INTRODUCTION

PIC32-WEB is low cost development board with the new high-performance 80MHz MIPS-Based 32-bit Flash microcontroller PIC32MX460F512L. Together with MOD-ENC624J600, PIC32-WEB give you opportunity to use web applications. UEXT and Prototype area gives users choice to connects a lot of our MOD boards and other users applications.

All this allows you to build a diversity of powerful applications to be used in a wide range of situations.

BOARD FEATURES

- PIC32MX460F512L microcontroller
- ICSP/ICD connector for programming and debugging with PIC-ICD2, PIC-ICD2-TINY and PIC-ICD2-POCKET.
- JTAG connector
- Reset button
- Three user buttons
- Trimmer
- RS232 driver and connector
- Power plug-in jack for 9V DC power supply
- Voltage regulator +3.3V - VR1(3.3V)
- Three user LEDs
- ACTIVITY and LINK leds
- Power on Led
- UEXT connector
- EXT1 and EXT2 connectors
- Prototype area
- PCB: FR-4, 1.5 mm (0,062"), solder mask, silkscreen component print
- Dimensions 100x60 mm (3.94x2.36")

ELECTROSTATIC WARNING

The PIC32-WEB board is shipped in protective anti-static packaging. The board must not be subject to high electrostatic potentials. General practice for working with static sensitive devices should be applied when working with this board.

BOARD USE REQUIREMENTS

Cables: Depends on the used programming/debugging tool. It could be 1.8 meter USB A-B cable to connect [PIC-ICD2](#) or [PIC-ICD2-POCKET](#) to USB host on PC or RS232 cable in case of [PIC-ICD2-TINY](#) or other programming/debugging tools. You will need a serial cable if not for programming, than for configuring the board. You will also need a USB OTG cable.

Hardware: Programmer/Debugger – most of Olimex programmers are applicable, for example [PIC-ICD2](#), [PIC-ICD2-POCKET](#), [PIC-ICD2-TINY](#) or other compatible programming/debugging tool.

!!!Warning!!! When you want to program this microcontroller with PIC-ICD2, PIC-ICD2-POCKET or PIC-ICD2-TINY, before connecting the programmer to your target board, you should first connect the programmer to your computer and open MPLAB. There, first from menu Configure – Select Device – choose the microcontroller you are about to program, then from menu Programmer – Select Programmer – choose MPLAB ICD 2, wait while MPLAB is downloading operation system, and after ICD2 is connected – check in menu Programmer – Settings – Power – there is option – Power target circuit from MPLAB ICD 2 – this option should be forbidden, you could not select it. Now it is safe to connect the programmer to your target board.

PROCESSOR FEATURES

PIC32-WEB board use High-Performance 32-bit RISC microcontroller PIC32MX460F512L from Microchip Technology Inc with these features:

- Operating Voltage Range of 2.3V to 3.6V
- 512K Flash Memory (plus an additional 12KB of Boot Flash)
- 32K SRAM Memory
- Pin-Compatible with Most PIC24/dsPIC® Devices
- Multiple Power Management Modes
- Multiple Interrupt Vectors with Individually Programmable Priority
- Fail-Safe Clock Monitor Mode
- Configurable Watchdog Timer with On-Chip Low-Power RC Oscillator for Reliable Operation

Peripheral Features:

- Atomic SET, CLEAR and INVERT Operation on Select Peripheral Registers
- Up to 4-Channel Hardware DMA with Automatic Data Size Detection
- USB 2.0 Compliant Full Speed Device and On-The-Go (OTG) Controller
- USB has a Dedicated DMA Channel

- 40 MHz Crystal Oscillator
- Internal 8 MHz and 32 kHz Oscillators
- Separate PLLs for CPU and USB Clocks
- Two I2C™ Modules
- Two UART Modules with:
 - RS-232, RS-485 and LIN 1.2 support
 - IrDA® with On-Chip Hardware Encoder and Decoder
- Parallel Master and Slave Port (PMP/PSP) with 8-bit and 16-bit Data and Up to 16 Address Lines
- Hardware Real-Time Clock/Calendar (RTCC)
- Five 16-bit Timers/Counters (two 16-bit pairs combine to create two 32-bit timers)
- Five Capture Inputs
- Five Compare/PWM Outputs
- Five External Interrupt Pins
- High-Speed I/O Pins Capable of Toggling at 80 MHz
- High-Current Sink/Source (18 mA/18 mA) on All I/O Pins
- Configurable Open-Drain Output on Digital I/O Pins

Debug Features:

- Two Programming and Debugging Interfaces:
 - 2-Wire Interface with Unintrusive Access and Real-time Data Exchange with Application
 - 4-wire MIPS® Standard Enhanced JTAG interface
- Unintrusive Hardware-Based Instruction Trace
- IEEE Std 1149.2 Compatible (JTAG) Boundary Scan

Analog Features:

- 16-Channel 10-bit Analog-to-Digital Converter:
 - 1000 ksps Conversion Rate
 - Conversion Available During Sleep, Idle
- Two Analog Comparators
- 5V Tolerant Input Pins (digital pins only)

BLOCK DIAGRAM

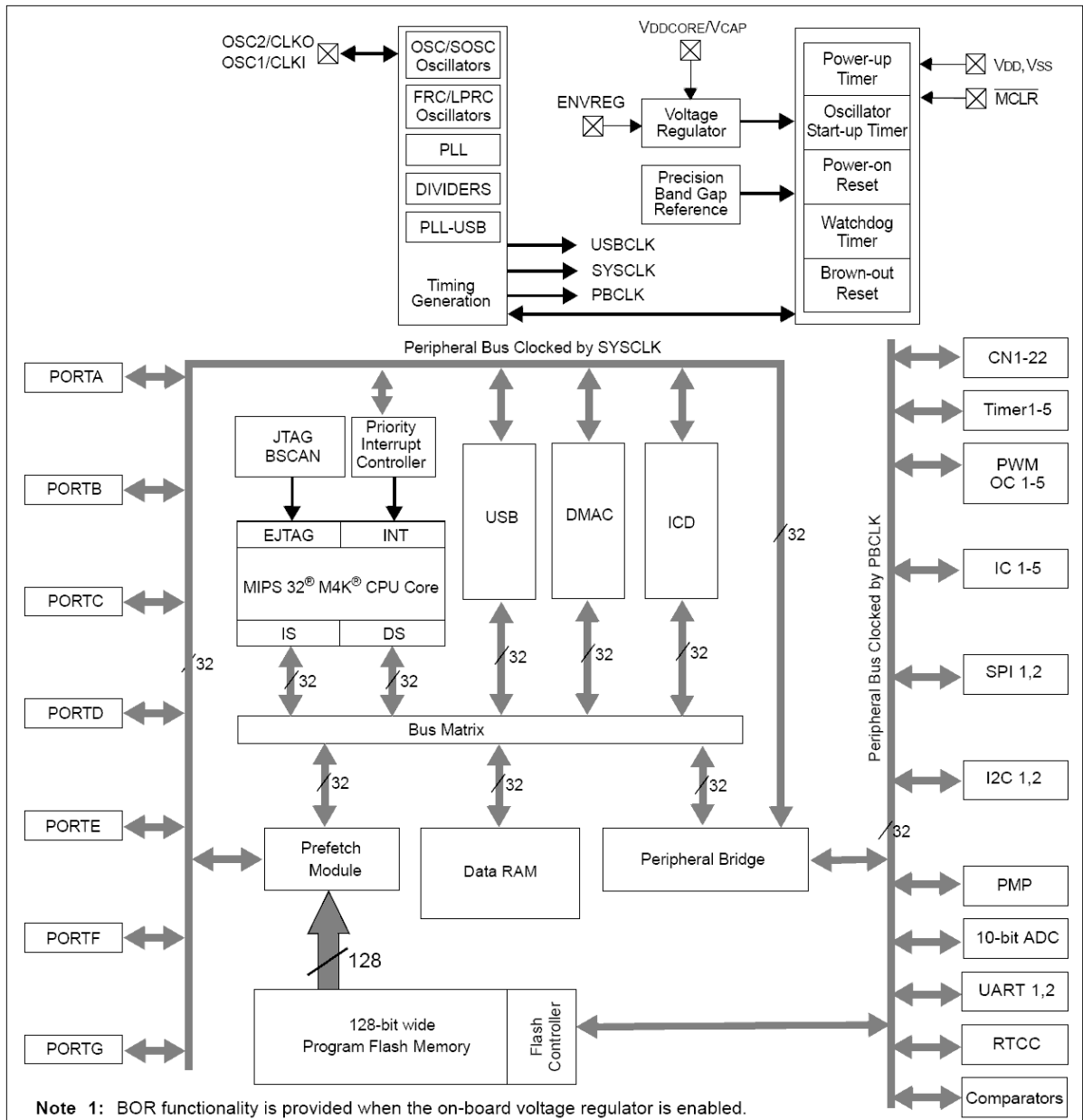

MEMORY MAP

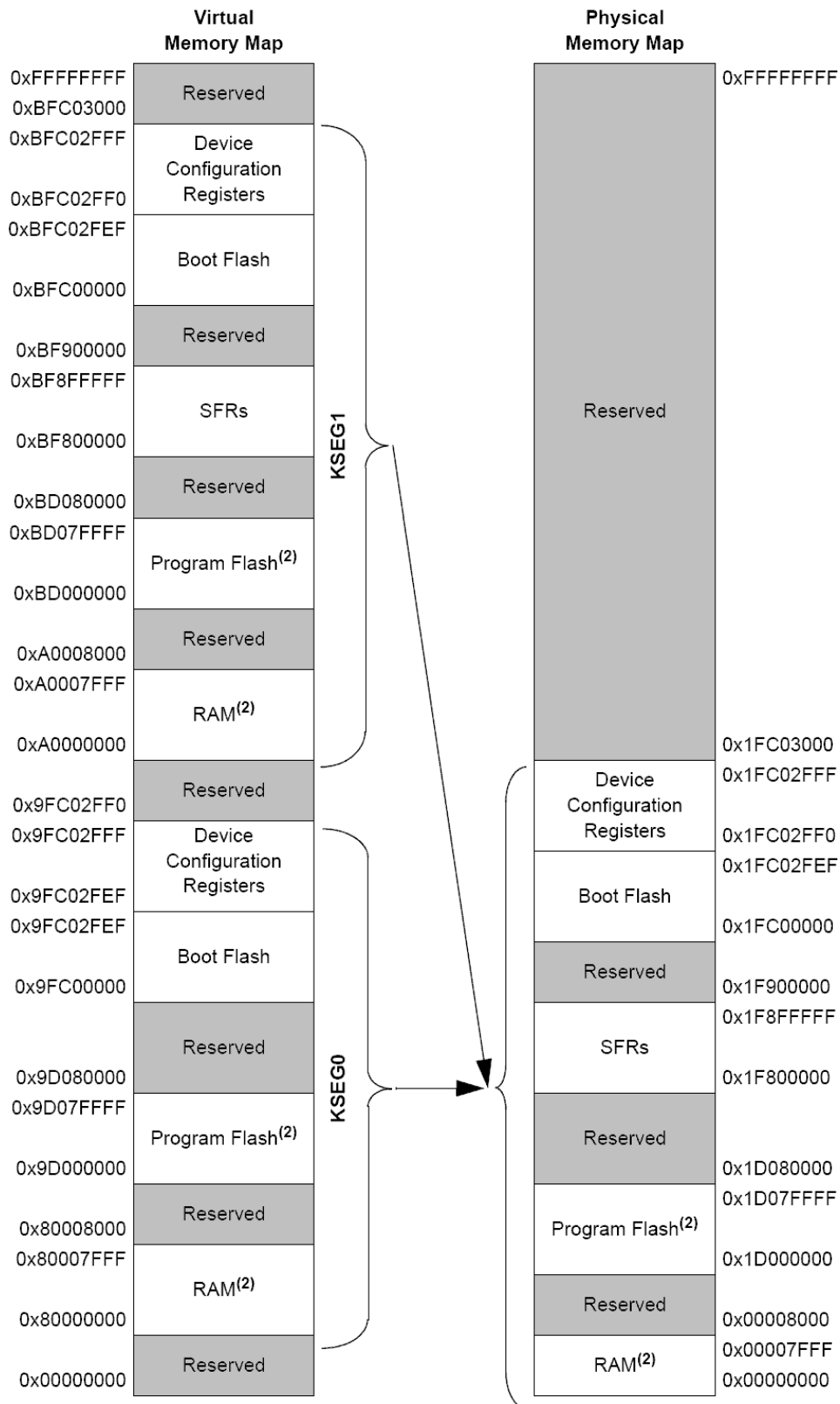

Note 1: Memory areas are not shown to scale.

2: The size of this memory region is programmable and can be changed by initialization code provided by end-user development tools (refer to the specific development tool documentation for information).

SCHEMATIC

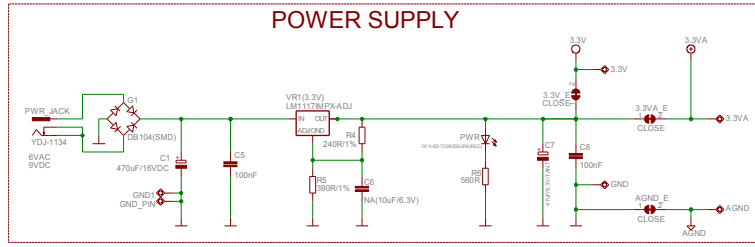
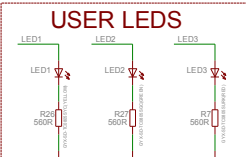
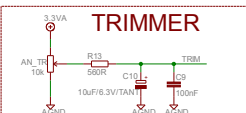
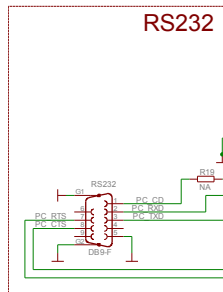
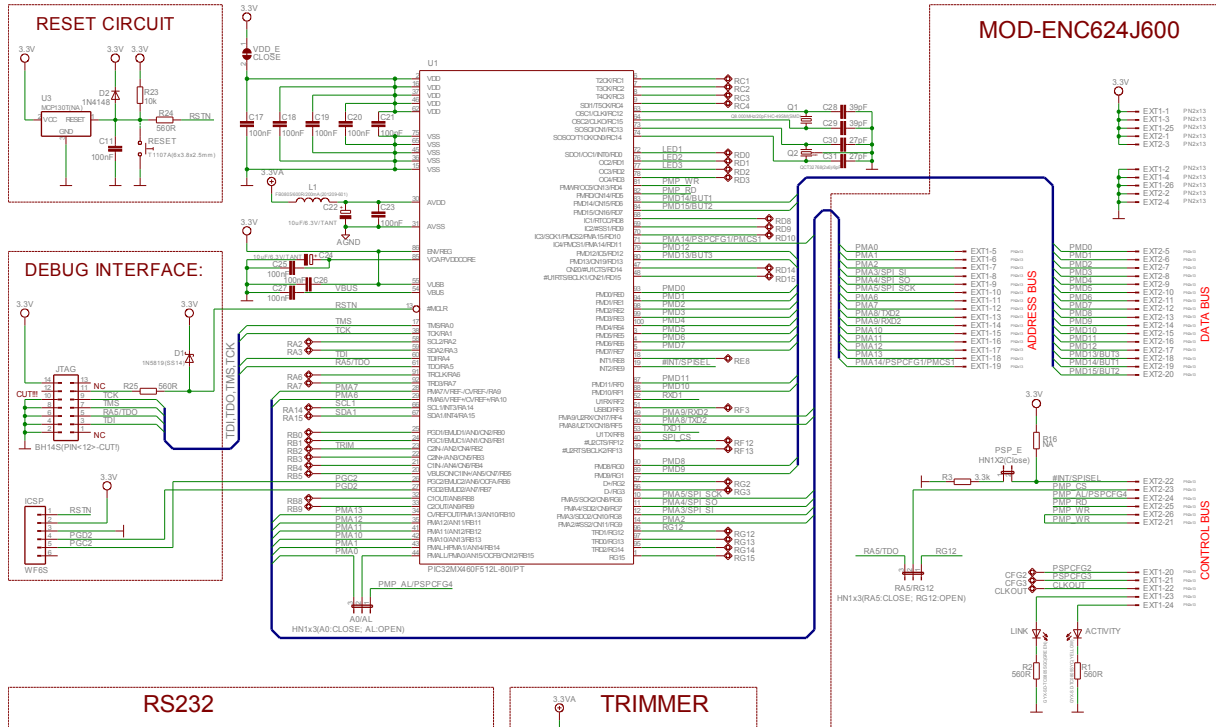

PIC32-WEB
 Rev. A
 COPYRIGHT(C) 2009
<http://www.dlmeex.com/dev>

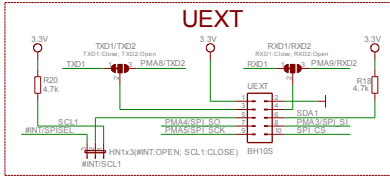
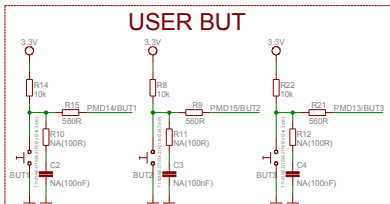

BOARD LAYOUT

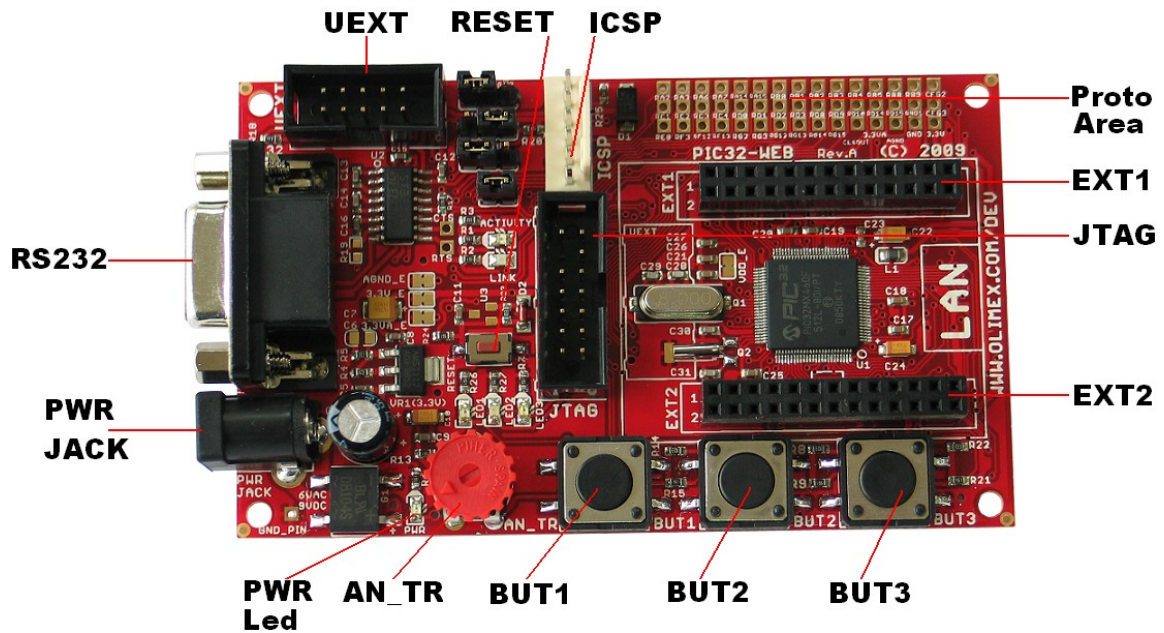

POWER SUPPLY CIRCUIT

PIC32-WEB can take power from PWR_JACK where 9V DC, or 6V AC is applied by external power source.

The board power consumption is: about 230 mA with all peripherals and microcontroller running at full speed, and 80 mA without MOD-ENC624J600.

RESET CIRCUIT

PIC32-WEB reset circuit is made with D2 (1N4148), C11 (100nF), R23 (10k) pull-up, R24 (560R) serial resistor and RST button.

CLOCK CIRCUIT

Quartz crystal 8MHz is connected to PIC32MX460F512L pin 63 (OSC1/CLKI/RC12) and pin 64 (OSC2/CLKO/RC15).

Quartz crystal 32.768 KHz is connected to PIC32MX460F512L pin 73 (SOSCI/CN1/RC13) and pin 74 (SOSCO/T1CK/CN0/RC14).

JUMPER DESCRIPTION

3.3V_E



Enable 3.3V board digital power supply.
Default state is closed.

3.3VA_E



Enable 3.3V board analog power supply.
Default state is closed.

VDD_E



Enable PIC32MX460F512L power supply.
Default state is closed.

AGND_E



Enable board analog ground.
Default state is closed.

RXD1/RXD2



When is in position RXD1, connects UEXT pin 4 via R17 (560 Ohm) to U2 (ST232) pin (12)R1OUT.
When is in position RXD2, connects UEXT pin 4 to PIC32MX460F512L pin 49 (PMA9/U2RX).
Default state is RXD1 closed.

TXD1/TXD2



When is in position TXD1, connects UEXT pin 3 to U2 (ST232) pin 11 (T1IN).
When is in position TXD2, connects UEXT pin 3 to PIC32MX460F512L pin 50 (PMA8/U2TX).
Default state is TXD1 closed.

RA5/RG12



Default state is RA5 closed.

#INT/SCL1



Default state is SCL1 closed.

A0/AL



Default state is A0 closed.

PSP_E



Default state is closed.

Jumpers RA5/RG12, #INT/SCL1, A0/AL and PSP_E work description

When ENC624J600 is in PSP MODE, only this can be used!!!		When ENC624J600 is in SPI MODE
PSP MODE 9	PSP MODE 3	Connected to SPI2
<p>MOD-ENC624J600 jumpers have to be: CFG4 → 0 CFG3 → 1 CFG2 → 1 CFG1 → 0 PSP_E → open</p> <p>PIC32-WEB jumpers have to be: PSP_E → close A0/AL → A0 – open, AL – close RA5/RG12 → RA5 - close, RG12 – open #INT/SCL1 → #INT – open, SCL1 - close</p>	<p>MOD-ENC624J600 jumpers have to be: CFG4 → 0 CFG3 → 0 CFG2 → 1 CFG1 → 0 PSP_E → open</p> <p>PIC32-WEB jumpers have to be: PSP_E → close A0/AL → A0 – close, AL – open RA5/RG12 → RA5 - close, RG12 – open #INT/SCL1 → #INT – open, SCL1 - close</p>	<p>MOD-ENC624J600 jumpers have to be: CFG4 → Doesn't matter! CFG3 → Doesn't matter! CFG2 → Doesn't matter! CFG1 → Doesn't matter! PSP_E → open</p> <p>PIC32-WEB jumpers have to be: PSP_E → open A0/AL → Doesn't matter! RA5/RG12 → Doesn't matter! #INT/SCL1 → #INT – open, SCL1 - close</p>
<p>Default jumpers position have to be in PSP MODE</p>		

INPUT/OUTPUT

User LED (yellow) with name **LED1** connected to PIC32MX460F512L pin 72 (SDO1/OC1/INT0/RD0).

User LED (green) with name **LED2** connected to PIC32MX460F512L pin 76 (OC2/RD1).

User LED (red) with name **LED3** connected to PIC32MX460F512L pin 77 (OSC3/RD2).

Power supply LED (red) with name **PWR** – indicates that external power source is applied and board power supply is applied.

ACTIVITY LED (yellow) – connected to EXT1-24 pin. The function of this led is the same as the function of the yellow led of LAN connector. Works only on PSP mode.

LINK LED (green) – connected to EXT1-23 pin. The function of this led is the same as the function of the green led of LAN connector. Works only in PSP mode.

Reset button with name **RESET**, connected to PIC32MX460F512L pin 13 (#MCLR), ICSP pin 1 and through R25 (560) to JTAG pin 11.

User button with name **BUT1**, connected to PIC32MX460F512L pin 83 (PMD14).

User button with name **BUT2**, connected to PIC32MX460F512L pin 84 (PMD15).

User button with name **BUT3**, connected to PIC32MX460F512L pin 80 (PMD13).

Trimmer with name **AN_TR**, connected to PIC32MX460F512L pin 23 (RB2).

EXTERNAL CONNECTORS DESCRIPTION

JTAG

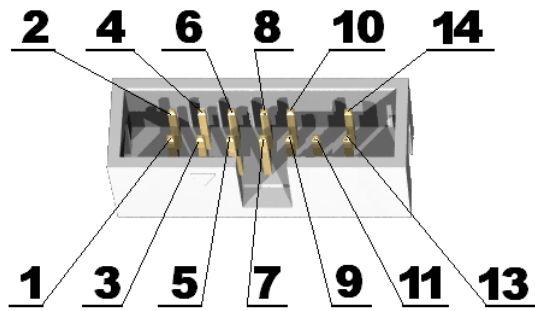

#Pin	Signal Name	#Pin	Signal Name
1	NC	2	GND
3	TDI	4	GND
5	RA5/TDO	6	GND
7	TMS	8	GND
9	TCK	10	GND
11	Through R25 to RSTN	12	Removed
13	NC	14	3.3V

ICSP

#Pin	Signal Name
1	RSTN
2	3.3V
3	GND
4	PGD2
5	PGC2
6	NC

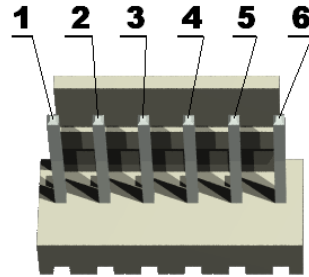

PWR JACK

Pin #	Signal Name
1	Power Input
2	GND

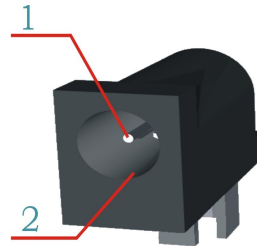

RS232

Pin #	Signal Name
1	PC_CD
2	PC_RXD
3	PC_TXD
4	NC
5	GND
6	NC
7	PC_RTS
8	PC_CTS
9	NC

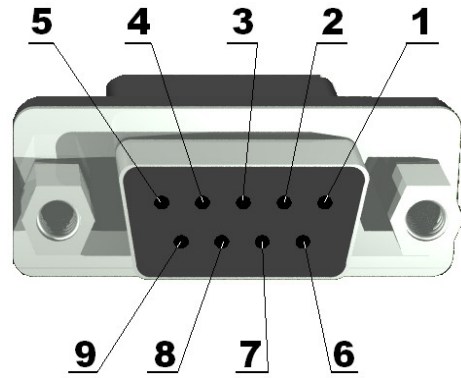

UEXT

Pin #	Signal Name
1	3.3V
2	GND
3	Jumper TXD1/TXD2
4	Jumper RXD1/RXD2
5	Jumper #INT/SCL1
6	SDA1
7	PMA4/SPI_SO
8	PMA3/SPI_SI
9	PMA5/SPI_SCK
10	SPI_CS

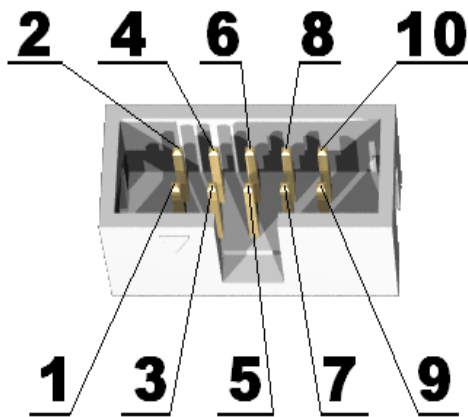

EXT1

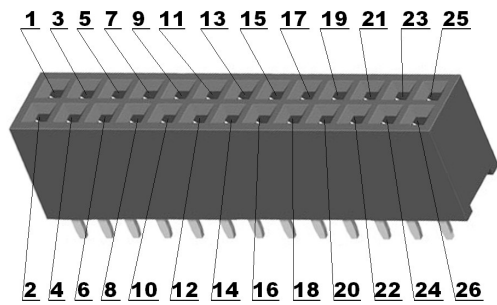

Pin #	Signal Name	Pin #	Signal Name
1	VCC	2	GND
3	VCC	4	GND
5	PMA0	6	PMA1
7	PMA2	8	PMA3/SPI_SI
9	PMA4/SPI_SO	10	PMA5/SPI_SCK
11	PMA6	12	PMA7
13	PMA8/TXD2	14	PMA9/RXD2
15	PMA10	16	PMA11
17	PMA12	18	PMA13
19	PMA14/PSPCFG1/PMCS1	20	PSPCFG2
21	PSPCFG3	22	CLKOUT
23	LINK	24	ACTIVITY
25	VCC	26	GND

EXT2

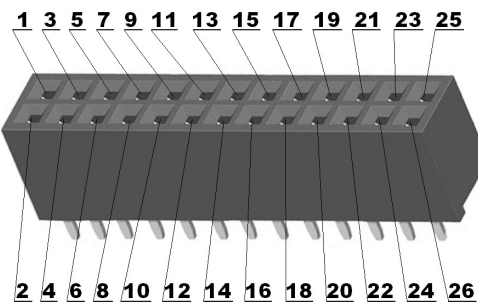

Pin #	Signal Name	Pin #	Signal Name
1	VCC	2	GND
3	VCC	4	GND
5	PMD0	6	PMD1
7	PMD2	8	PMD3
9	PMD4	10	PMD5

11	PMD6	12	PMD7
13	PMD8	14	PMD9
15	PMD10	16	PMD11
17	PMD12	18	PMD13/BUT3
19	PMD14/BUT1	20	PMD15/BUT2
21	PMP_WR	22	#INT/SPISEL
23	PMP_CS	24	PMP_AL/PSPCFG4
25	PMP_RD	26	PMP_WR

PROTOTYPE AREA

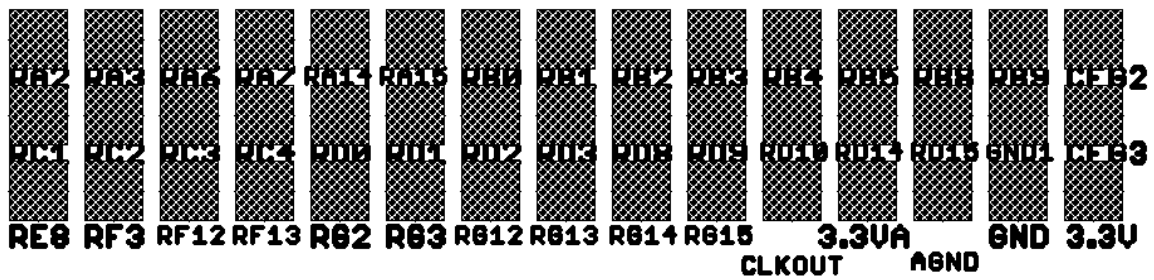

Pin #	Signal Name	Pin #	Signal Name	Pin #	Signal Name
1	RA2	2	RC1	3	RE8
4	RA3	5	RC2	6	RF3
7	RA6	8	RC3	9	RF12/SPI_CS
10	RA7	11	RC4	12	RF13
13	RA14/SCL1	14	RD0/LED1	15	RG2
16	RA15/SDA1	17	RD1/LED2	18	RG3
19	RB0	20	RD2/LED3	21	RG12
22	RB1	23	RD3	24	RG13
25	RB2/TRIM	26	RD8	27	RG14
28	RB3	29	RD9	30	RG15
31	RB4	32	RD10	33	CLKOUT
34	RB5	35	RD14	36	3.3VA
37	RB8	38	RD15	39	AGND
40	RB9	41	GND	42	GND
43	PSPCFG2	44	PSPCFG3	45	3.3V

SPI

- Master and Slave Modes Support
- Four Different Clock Formats
- Framed SPI Protocol Support

- User Configurable 8-bit, 16-bit and 32-bit Data Width
- Separate SPI Data Registers for Receive and Transmit
- Programmable Interrupt Event on every 8-bit, 16-bit and 32-bit Data Transfer
- Operation during CPU Sleep and Idle Mode
- Fast Bit Manipulation using CLR, SET and INV Registers

I²C

The PIC32MX460F512L microcontroller has two I²C interface modules, denoted as I2C1 and I2C2. Each I²C module has a 2-pin interface: the SCL_x pin is clock and the SDA_x pin is data.

Each I²C module 'I²C_x' (x = 1 or 2) offers the following key features:

- I²C Interface Supporting both Master and Slave Operation.
- I²C Slave Mode Supports 7 and 10-bit Address.
- I²C Master Mode Supports 7 and 10-bit Address.
- I²C Port allows Bidirectional Transfers between Master and Slaves.
- Serial Clock Synchronization for I²C Port can be used as a Handshake Mechanism to Suspend and Resume Serial Transfer (SCLREL control).
- I²C Supports Multi-master Operation; Detects Bus Collision and Arbitrates Accordingly.
- Provides Support for Address Bit Masking.

MECHANICAL DIMENSIONS

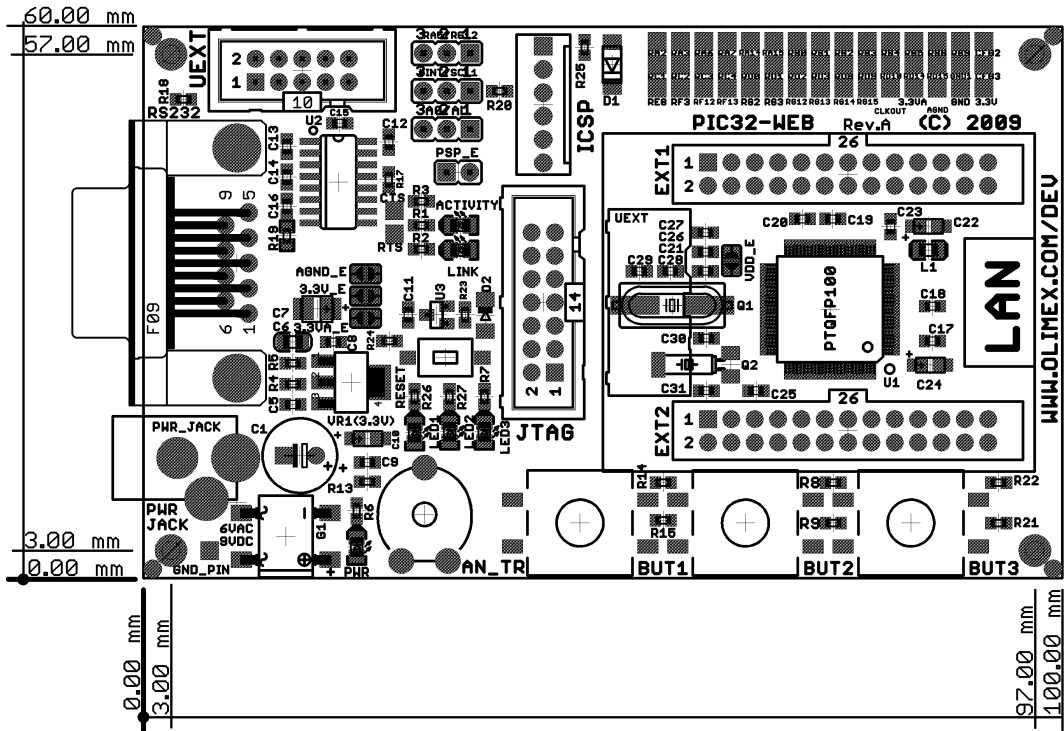

AVAILABLE DEMO SOFTWARE

- PSP_MODE_3
- SPI_MODE

ORDER CODE

PIC32-WEB - completely assembled and tested.

How to order?

You can order to us directly or by any of our distributors.

Check our web www.olimex.com/dev for more info.

Revision history:

REV. A - create November 2009

Disclaimer:

© 2009 Olimex Ltd. All rights reserved. Olimex®, logo and combinations thereof, are registered trademarks of Olimex Ltd. Other terms and product names may be trademarks of others.

The information in this document is provided in connection with Olimex products. No license, express or implied or otherwise, to any intellectual property right is granted by this document or in connection with the sale of Olimex products.

Neither the whole nor any part of the information contained in or the product described in this document may be adapted or reproduced in any material form except with the prior written permission of the copyright holder.

The product described in this document is subject to continuous development and improvements. All particulars of the product and its use contained in this document are given by OLIMEX in good faith. However all warranties implied or expressed including but not limited to implied warranties of merchantability or fitness for purpose are excluded.

This document is intended only to assist the reader in the use of the product. OLIMEX Ltd. shall not be liable for any loss or damage arising from the use of any information in this document or any error or omission in such information or any incorrect use of the product.